

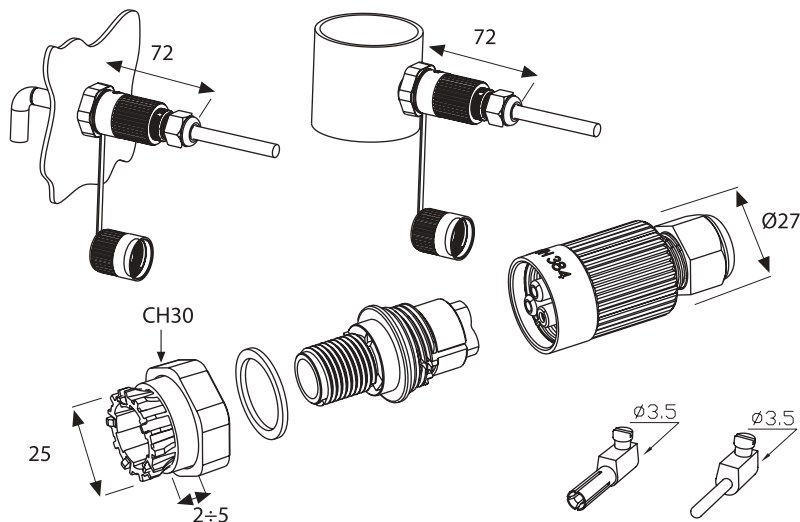

new



RoHS

Dimensioni in millimetri. Dimensions shown in millimetres.

IP67

Dati generali General data

Dati tecnici Technical data

N. poli	2	3	4	N. poles
Terminali	vite/perforazione/pin screw/piercing/crimp			Terminals
Sezione cavo	max 4.0 mm ² (bussola a vite screw terminals) 0.5 mm ² - 1.5 mm ² (bussola a perforazione piercing clip terminals)			Cable section
Diametro cavo ⁽²⁾	7.0 mm - 12.0 mm			Cable diameter ⁽²⁾
Grado di protezione (IP)	IP67			Degree of protection (IP)
Corrente e tensione nominale	17.5A 400V			Rated current and voltage
T marking	T85°C			T marking
Temperatura di funzionamento	-40°C to +125°C			Operating temperature
Categoria di sovratensione	II			Impulse withstand category
Tensione di tenuta ad impulso	4 kV			Impulse withstand voltage
Grado di inquinamento	2			Pollution degree
Indice di tracking	PTI 175			Tracking index

Materie prime Raw materials

Corpo plastico	PA66 UL94 V0/V2 GWT 850°C nero black - grigio grey RAL7035	Connector housing
Corpo plastico morsettiera e dadi	PA66 GF UL94 V0 GWT 960°C ⁽¹⁾ nero black - grigio grey RAL7035	Terminal block housing and lock nuts
Gommini di tenuta cavo e guarnizioni	TPE/silicone	Grommets and seals
Bussole	ottone nichelato brass nickel plated ottone argentato brass silver plated (AG)	Contact screw terminals
Viti standard	M3 acciaio zincato passivato steel zinc plated	Standard screws
Viti perforazione	M3 acciaio zincato ottonato steel zinc brass plated	Piercing screws

Norme Standards

EN61984:2001 EN60998-1:2004 EN60998-2-1:2004 EN60529:1991+A1:2000

Note: (1) Vedi TH023. See TH023.

(2) Per cavi $\phi \leq 7.0$ mm si consiglia l'utilizzo dell'accessorio codice 6000347LA. For cable $\phi \leq 7.0$ mm it is recommended to use the accessory code 6000347LA.

Eventuali modifiche e migliorie sui dati tecnici o sul prodotto potranno essere effettuate senza preavviso.
All technical data or other eventual product modifications and improvements can be carried out without notice.

TH386

PATENTED

 CONNETTORE PRESA-SPINA PROTETTO DA PARETE AD AGGANCIAMENTO RAPIDO. 2-3-4 POLI.
 PANEL MOUNTED SELF-LOCKING PLUG AND SOCKET CONNECTOR. 2-3-4 POLES.















TH386





Codice Order number

Bussole Inserts (17.5A)

versione version	n. poli n. poles	bussola contact terminal	pz/imb pcs/box	codice order number	
 PLUG	2		200	THB.386. A2A	
 POWER SOCKET 			200	THB.384. B2A	
 PLUG	3		200	THB.386. A1A	
 POWER SOCKET 			200	THB.384. B1A	
Le versioni sopra indicate sono disponibili con terminali a perforazione di isolante. The above versions are available with piercing clip terminal blocks.				200	THP.386.AXX
				200	THP.384.BXX

Pin Crimp (10A)

versione version	n. poli n. poles	pin crimp	pz/imb pcs/box	codice order number
 PLUG	2		200	THF.386. A2A
 POWER SOCKET 			200	THF.384. B2A
 PLUG	3		200	THF.386. A1A
 POWER SOCKET 			200	THF.384. B1A
 PLUG	4		200	THF.386. A4A
 POWER SOCKET 			200	THF.384. B4A

Note:   Bussole con vite. Per sezioni cavo < 1.0 mm² si consiglia l'utilizzo del puntalino. Contact screw terminals. For cable section < 1.0 mm² we suggest to use a cable tip.
  Bussola a perforazione max 1.5 mm². Piercing clip terminal max 1.5 mm².
  Per pin cilindrici universali Ø 2 mm (non forniti). For universal cylindrical pin Ø 2 mm (not supplied).

Entrambe le custodie dei connettori possono ricevere indistintamente il frutto maschio o femmina. Per ragioni di sicurezza, solo il frutto femmina deve essere utilizzato per portare tensione.
 Every connector housing type can be equipped with male or female contacts. For reasons pertaining to safety, only female contacts may be used in the live part of the connector.

Varianti Options



Bussole Contact Terminals

versione version	codice order number
Bussole in ottone argentato <i>brass silver plated contact screw terminals</i>	THX.386.XXX.AG
	THX.384.XXX.AG

Colore Colour Contatta il Servizio Clienti per maggiori informazioni. *Contact our Customer Service for availability.*

versione version	codice order number
<input checked="" type="checkbox"/> grigio grey RAL 7035	THX.386.XXX.CG
	THX.384.XXX.CG
<input type="checkbox"/> altri colori <i>other colours</i>	THX.386.XXX.CX
	THX.384.XXX.CX

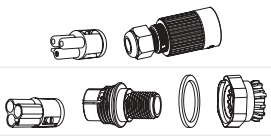
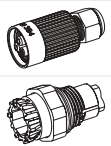
Kit di fornitura Purchasing kit

versione version	misure imballaggio box dimensions	contenuto contents	pz/imb pcs/box	codice order number
kit non assemblato <i>unassembled kit</i>	C05 (395x395x185 mm)		200	THX.384.XXX
kit assemblato <i>assembled kit</i>	C05 (395x395x185 mm)		200	THX.384.XXX.Z
				THX.386.XXX.Z
Note: Fornito con tappo di chiusura. <i>Supplied with closure cap.</i>				
kit imbustato <i>retail pack kit</i>	--		--	THX.386.XXX.R
versione speciale <i>custom version</i>	*	*	*	THX.386.XXX.K

Note: Per maggiori informazioni sugli accessori consulta pagina 252. Per maggiori informazioni sulle istruzioni di assemblaggio consulta www.techno.it.
For more information about accessories see page 252. For more information about assembling instructions see www.techno.it.

*** Sono possibili personalizzazioni di prodotto e progetti su richieste specifiche. Contatta il Servizio Clienti.**
Personalization and new custom products are possible. Please contact our Customer Service.

Eventuali modifiche e migliorie sui dati tecnici o sul prodotto potranno essere effettuate senza preavviso.
All technical data or other eventual product modifications and improvements can be carried out without notice.

Caratteristiche e vantaggi *Features and benefits*

Guarda il video su www.techno.it Watch the video on www.techno.it



Connettore presa-spina installabile su superficie piana o curva.
Plug and Socket connector can install on flat or curve surface.



Installazione rapida e intuitiva. Ancoraggio rapido senza necessità di contro-dado. Installazione possibile anche in situazioni speciali.
Fast and intuitive installation. Quick anchoring without nut in the rear. Useful for installation in special situation.



Connessione sicura e protetta. Inserimento veloce del maschio e della femmina per garantire una connessione IP67.
Safety and protected connection. Fast inserting of plug into socket to get a IP67 waterproof connection.



Installazione rapida e intuitiva. Sistemi di aggancio-sgancio rapido con ghiera di blocco per maggiore affidabilità.
Fast and intuitive installation. Quick locking systems with threaded lock nut to guarantee a better protection degree.

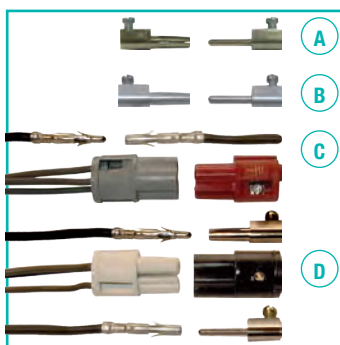

Inserti disponibili in versione: A) vite in ottone nichelato, B) vite in ottone argentato, C) inserti a crimpare, D) ibrida con viti e inserti.
Metal inserts available: A) brass nickel plated screws, B) brass silver plated screws, C) standard crimp, D) hybrid with screws and crimp.



Cablaggio veloce. Viti delle bussole disponibili nella versione: A) con punta piatta, B) con punta a perforazione di isolante senza la necessità di spelare la guaina.
Quick wiring. Screws available: A) standard screw, B) piercing screws without the need for stripping the sheath.



Personalizzabili. Versioni trasparenti e colorate su richiesta del cliente.
Custom products. Transparent and colour versions on customer request.



Compatibilità con guaine corrugate, guida cavi e calze espandibili.
Fitting with braided hose, spiral top and cable protection systems.



Protezione dalla condensa con resina isolante, garantisce l'integrità degli apparecchi nel tempo.
Protection from moisture condensation with a special resin with excellent insulation capacity, ensures integrity of equipments over time.

Eventuali modifiche e migliorie sui dati tecnici o sul prodotto potranno essere effettuate senza preavviso.
All technical data or other eventual product modifications and improvements can be carried out without notice.