

G10XX, TYPE B SERIES

NEW SUPER ECON-PLASTIC PLASTIC PROJECT CASES

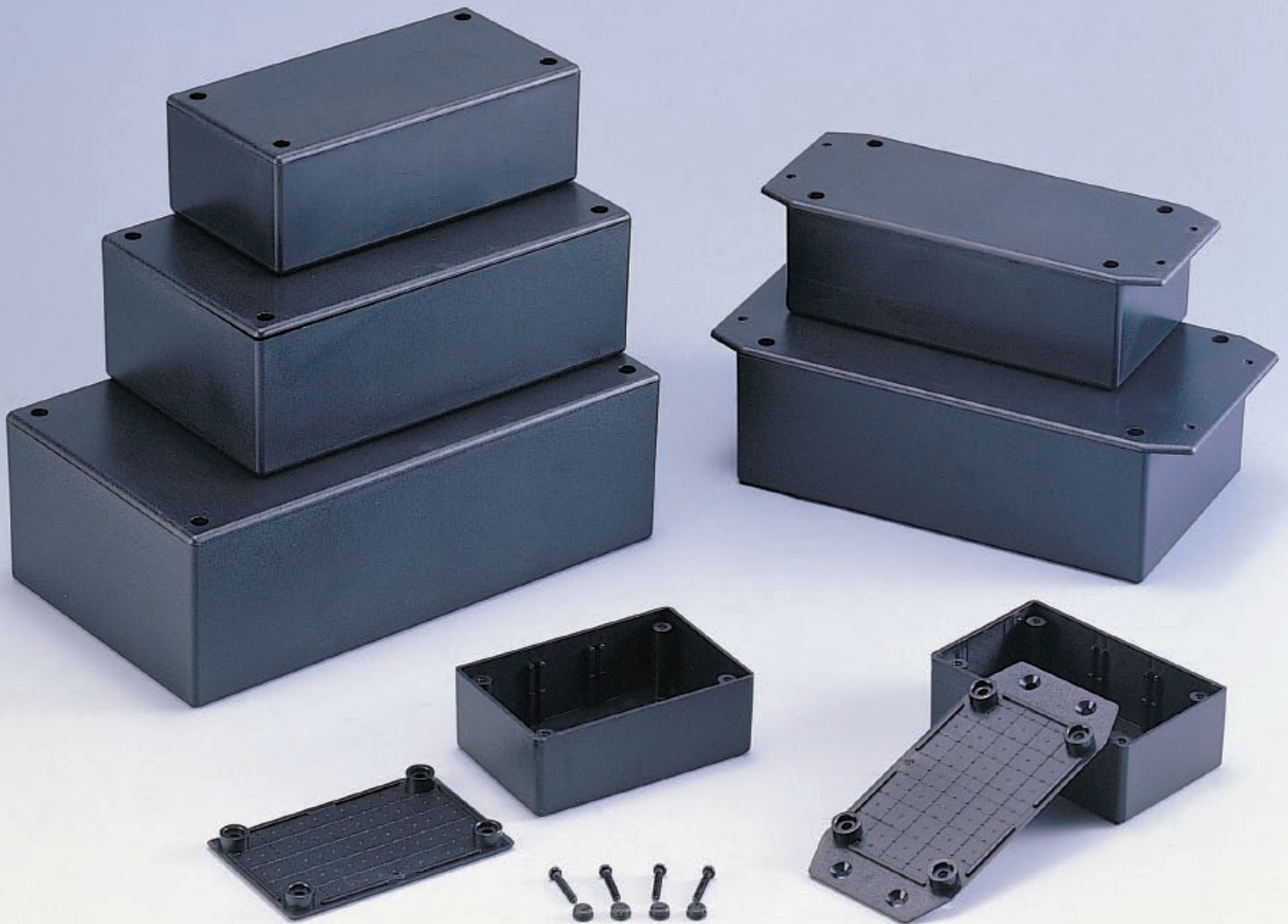

PRODUCT INFORMATION

MATERIAL:

- High impact ABS plastic UL94-HB.

FEATURES:

- The special retaining rails can hold PCB horizontally and vertically.
- There are recessed grids on top lid and bottom for users to make cutouts and central points easily.
- 4 pcs screws and 4 pcs screws plugs are included.

ITEM No.	EXTERNAL DIMENSION(mm)
G1020B	54 X 83 X 30
G1022B	68 X 130 X 44
G1024B	95 X 157.8 X 53
G1025B	113 X 197.4 X 63
G1020BF	54 X 83 X 30
G1022BF	68 X 130 X 44
G1024BF	95 X 157.8 X 53
G1025BF	113 X 197.4 X 63

- Special color is available on request

G1020B

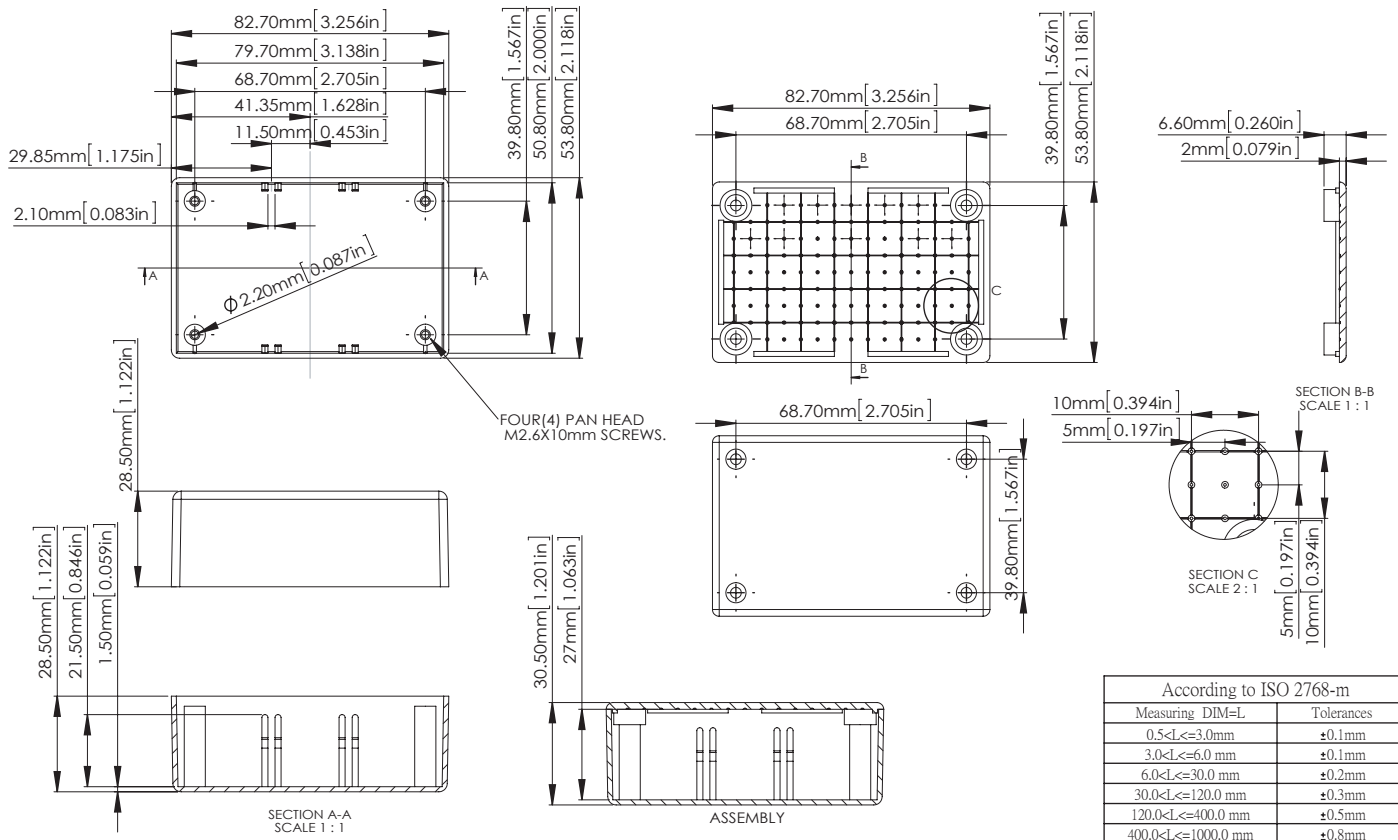

According to ISO 2768-m

Measuring DIM=L	Tolerances
0.5<L≤3.0mm	±0.1mm
3.0<L≤6.0 mm	±0.1mm
6.0<L≤30.0 mm	±0.2mm
30.0<L≤120.0 mm	±0.3mm
120.0<L≤400.0 mm	±0.5mm
400.0<L≤1000.0 mm	±0.8mm

G1022B

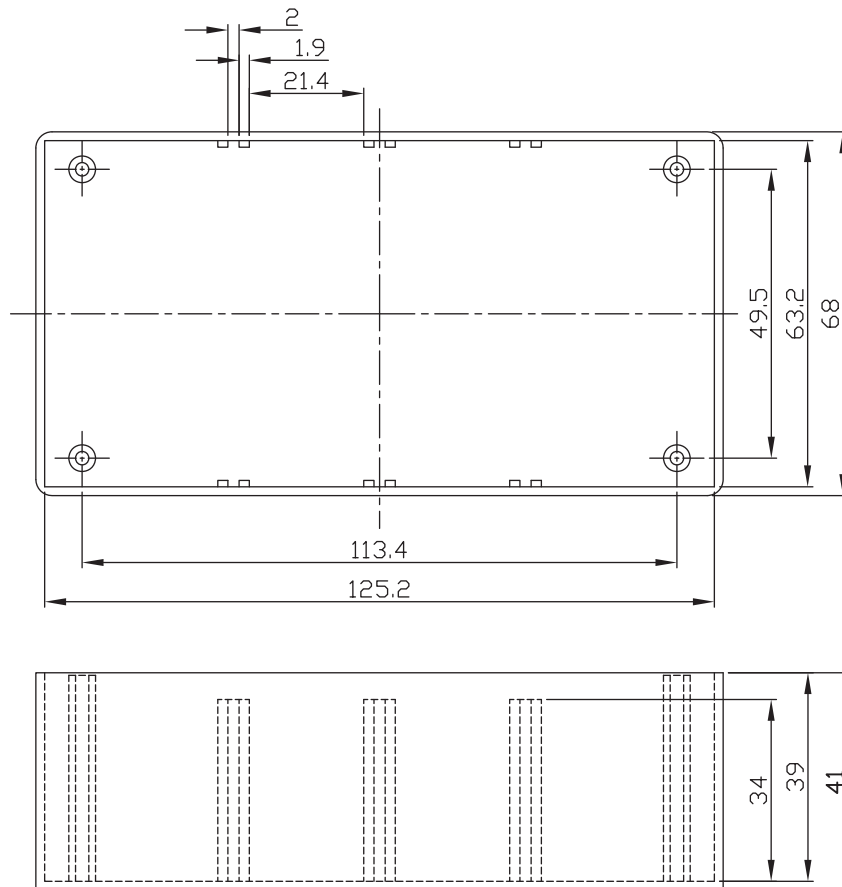

G1024B

G1024T

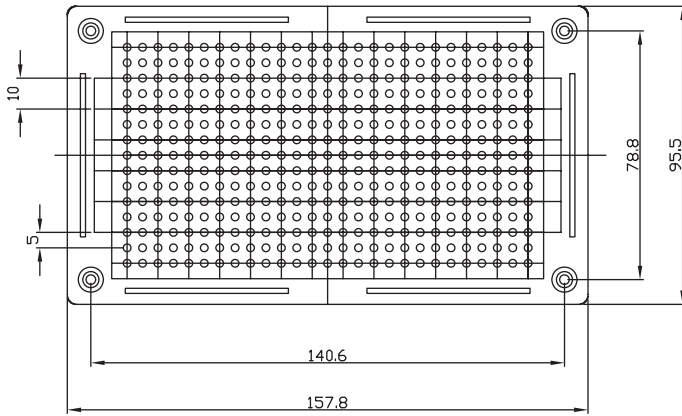

G1024B

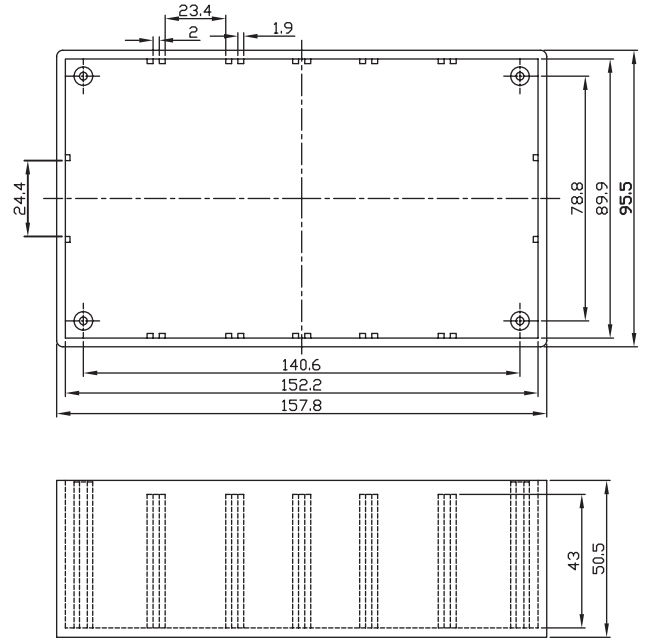

G1025B

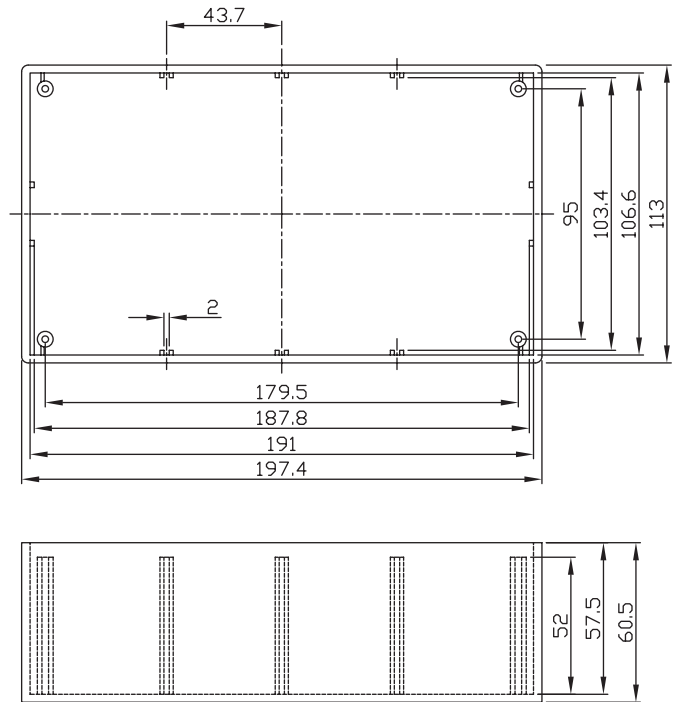
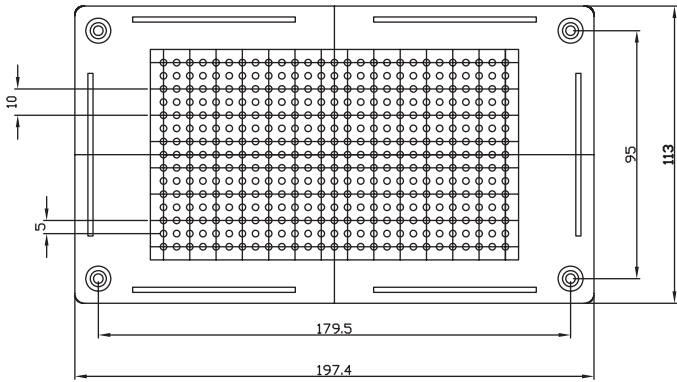

G1020BF

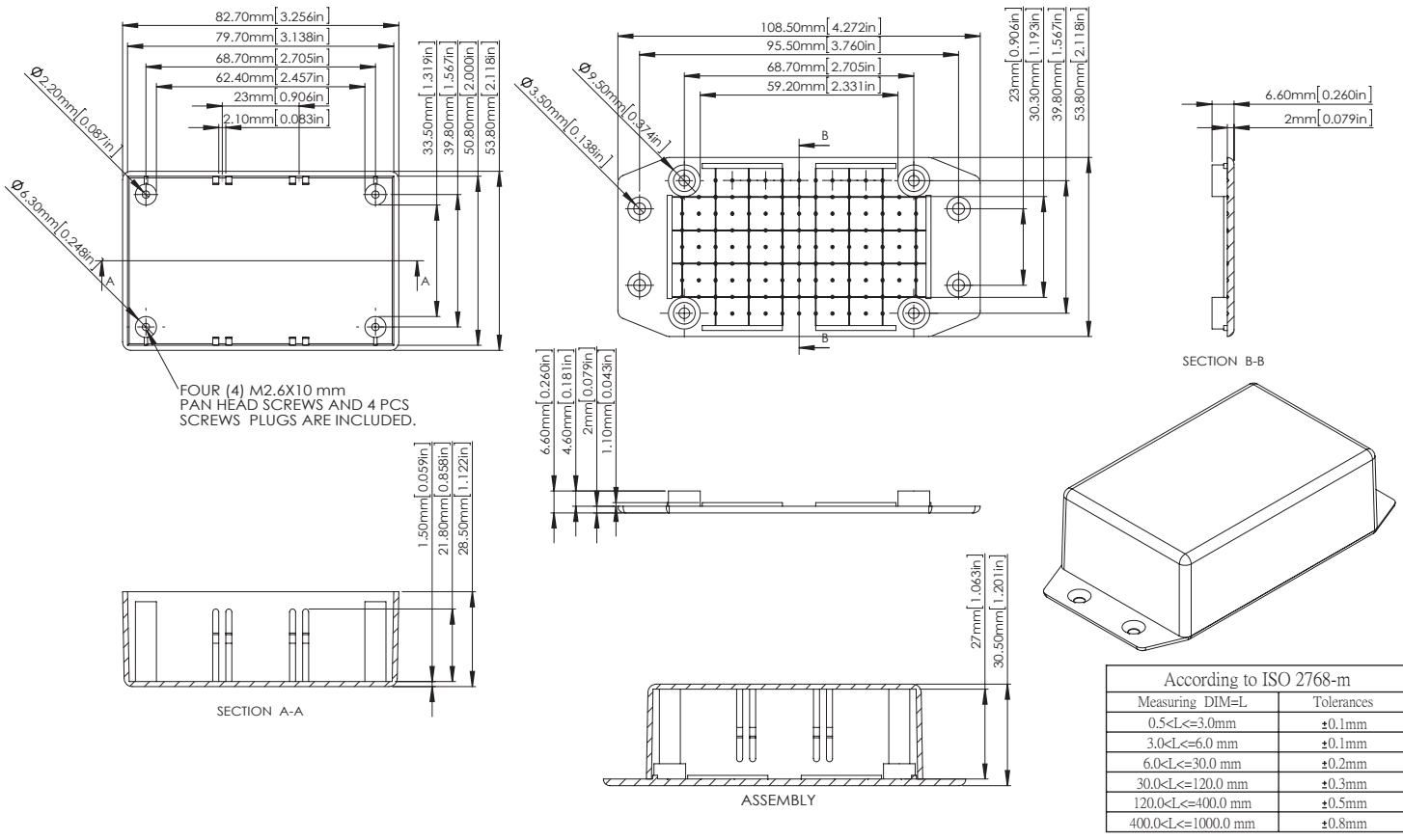

G1022BF / G1024BF / G1025BF

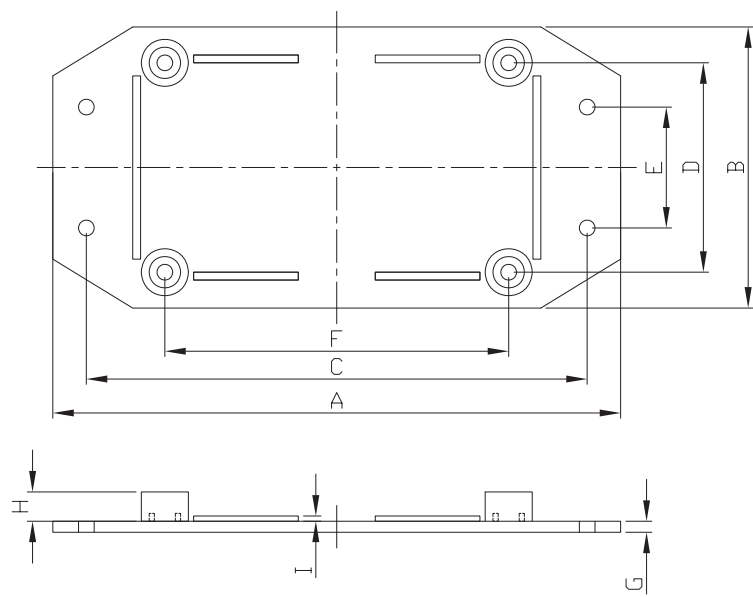

*PLASTIC BOX WITH PLASTIC FLANGED LID FOR WALL MOUNTING.

DIMENSION IN (mm)

STOCK NO.	A	B	C	D	E	F	G	H	I
G1022BF	156.0	67.1	143.1	49.5	30.4	113.2	2.6	3.5	1.0
G1024BF	185.7	95.5	171.0	78.8	55.0	140.6	2.6	3.5	1.0
G1025BF	225.0	113.0	211.0	95.0	60.1	179.5	2.8	3.5	1.0

REGARDING THE DIMENSION OF BASE , PLEASE REFER TO DRAWINGS OF G1020 SERIES.